

## SYSTEM

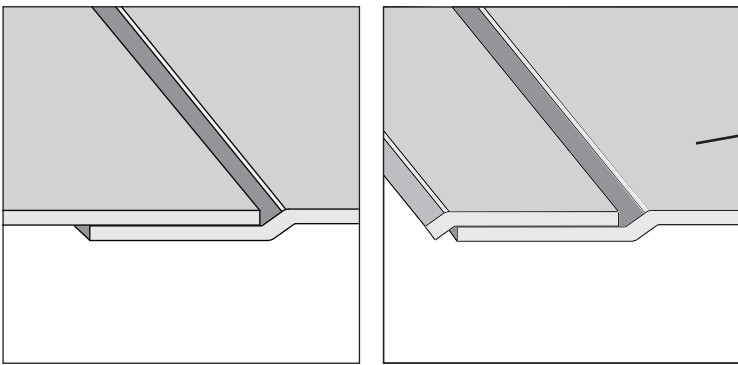

Panel Overlap

End Closure Bar

### Diagram A

**Exploded view of Terrace Panels** in a layout using panels of the same size. Panels are attached with screws and adhesive onto wall.

**Two (2) End Closure Bars** are included for each installation.

## STANDARD FEATURES

- Complete engineered system, packaged and shipped ready to install
- Panels available with any of our 25 colors and 14 patterns and Blendz
- Finishes are available, with gloss and satin options
- Available in .090" aluminum thickness

## Applications

- Healthcare
- Hospitality
- Transportation
- Corporate
- Institutional
- Remodels
- Tenant Improvements
- New Construction

## ADDITIONAL OPTIONS

- Baseboard available in stainless steel in flat or 3/4" deep styles (6" high)
- Chair rail available (6" high)
- Corner trim (1 1/2" x 1 1/2")
- Edge trim (1" wide)
- Panel shapes available in Custom sizes (contact factory).

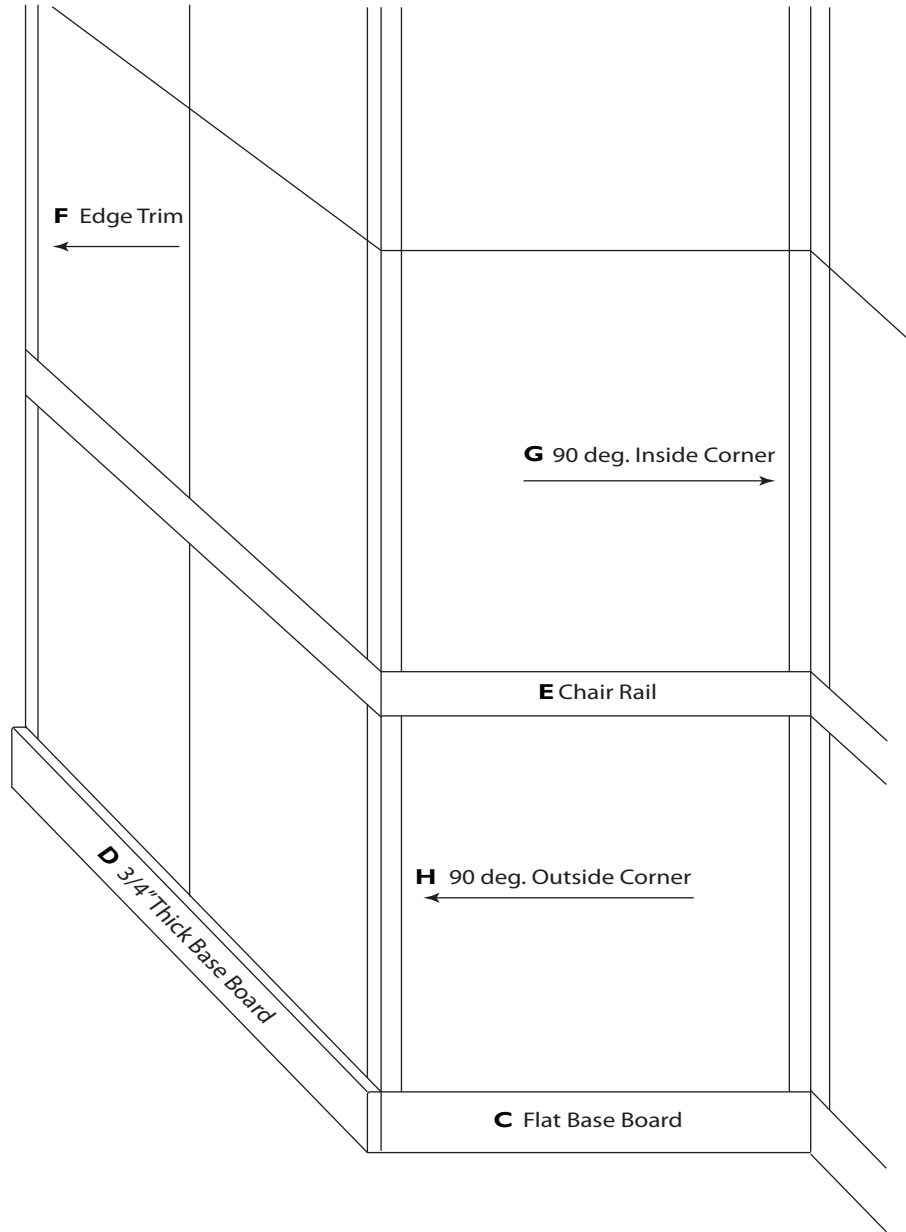

### BASE BOARD

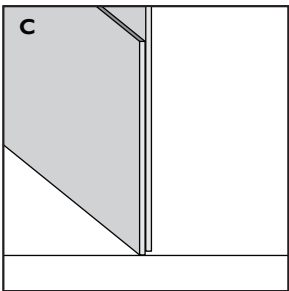

Flat Base Board

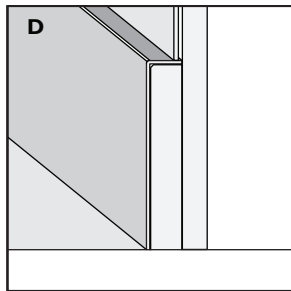

3/4" Thick Base Board

### ACCESSORIES

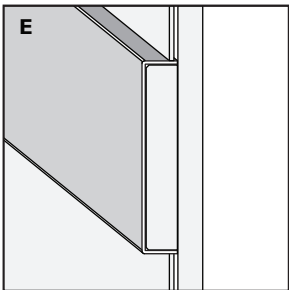

Chair Rail

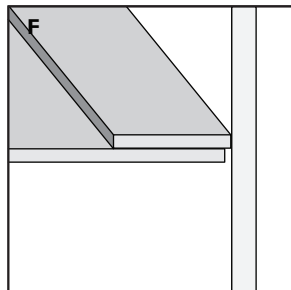

Edge Trim

### CORNER TRIM

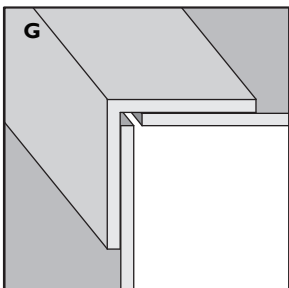

Inside

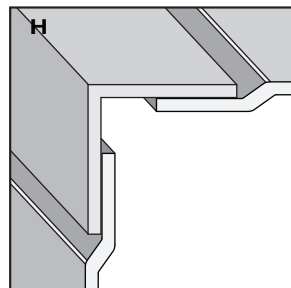

Outside

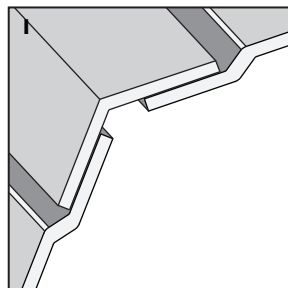

Custom (not shown on drawing)